

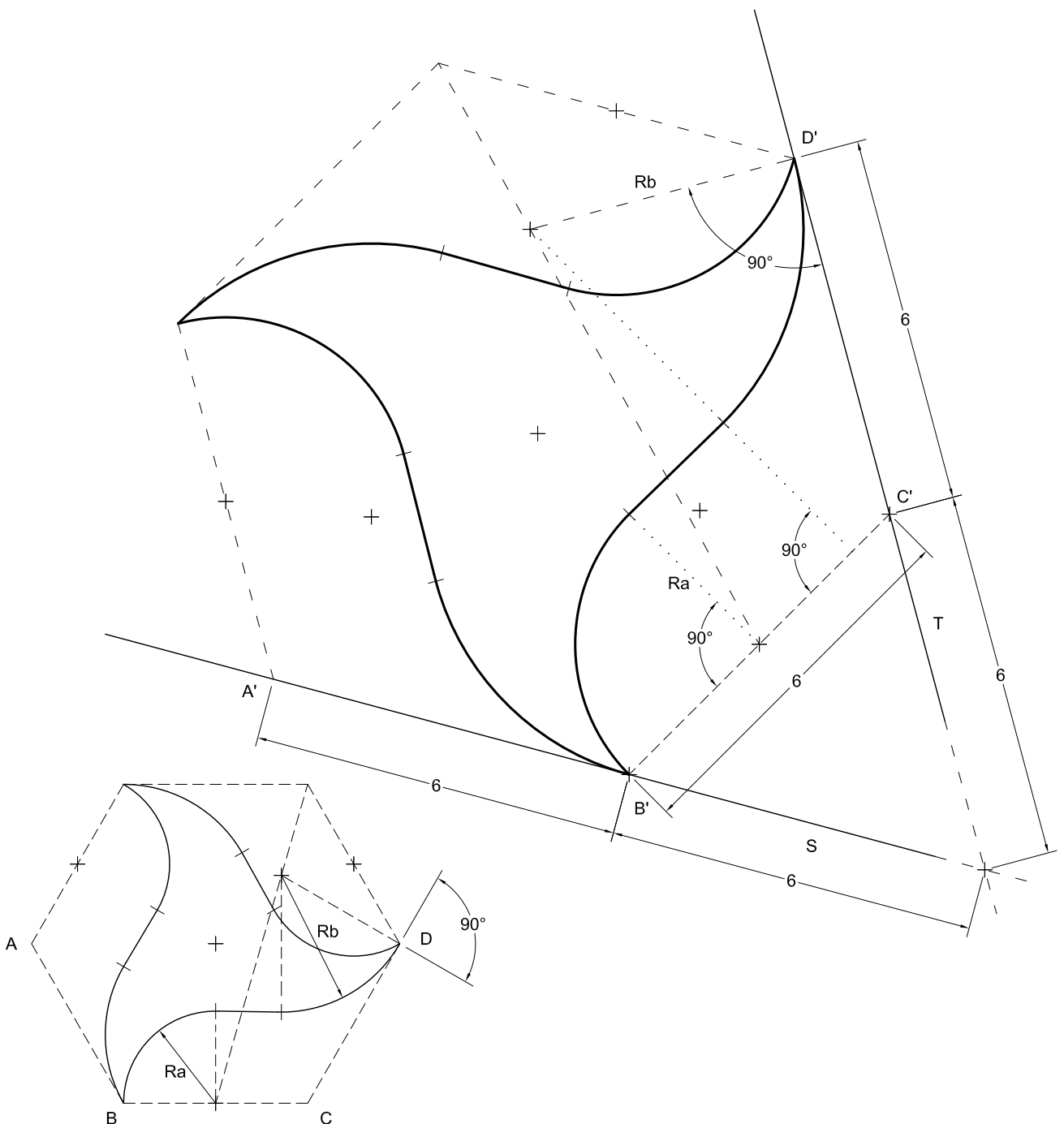

SÈRIE 2

( 1A)

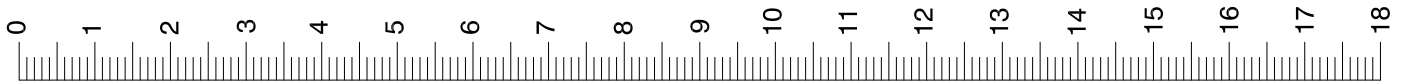



( 1B)

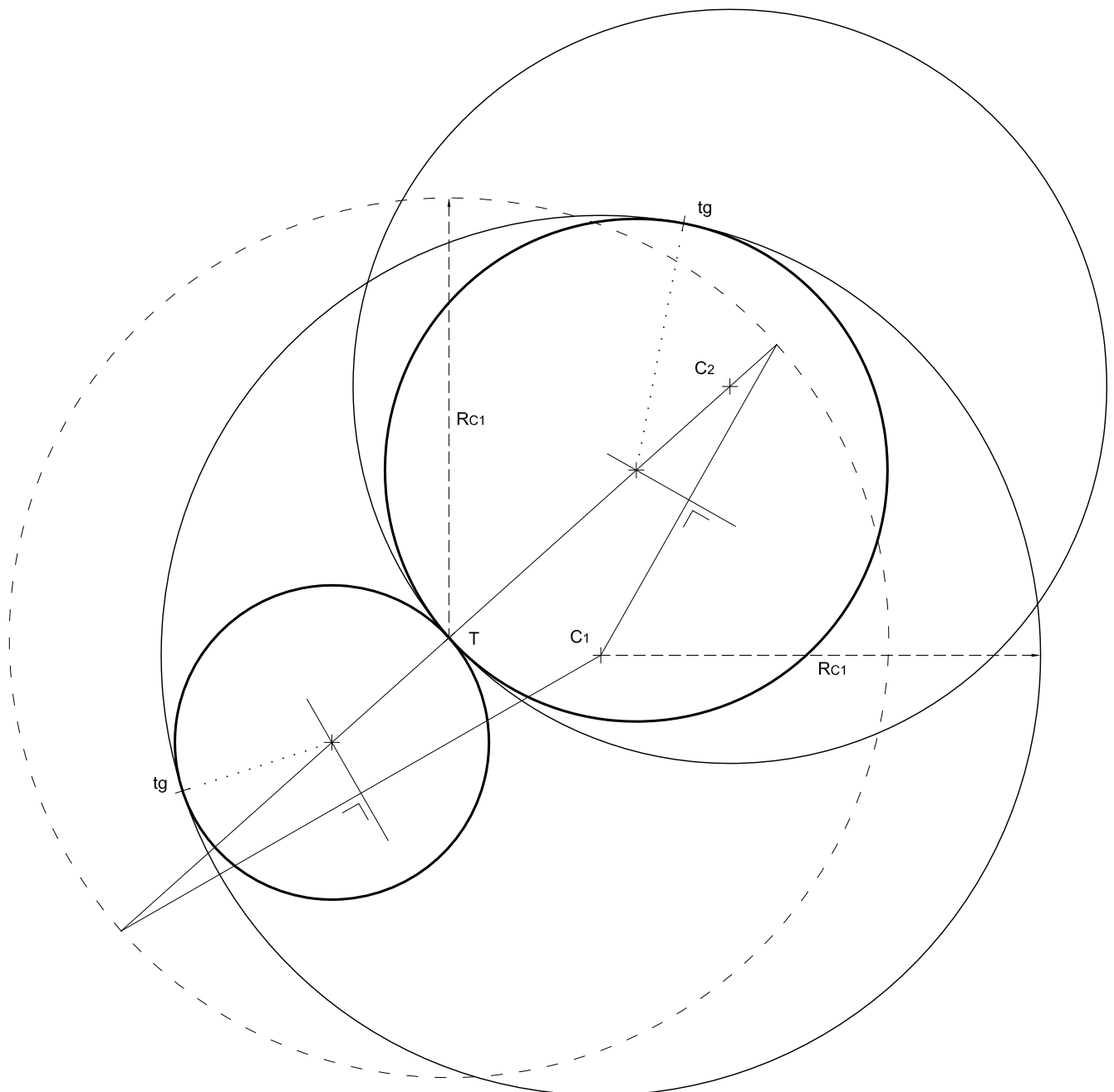
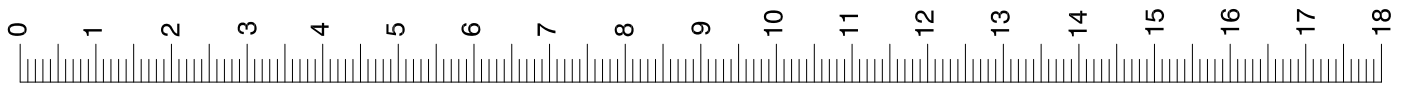



( 2A)

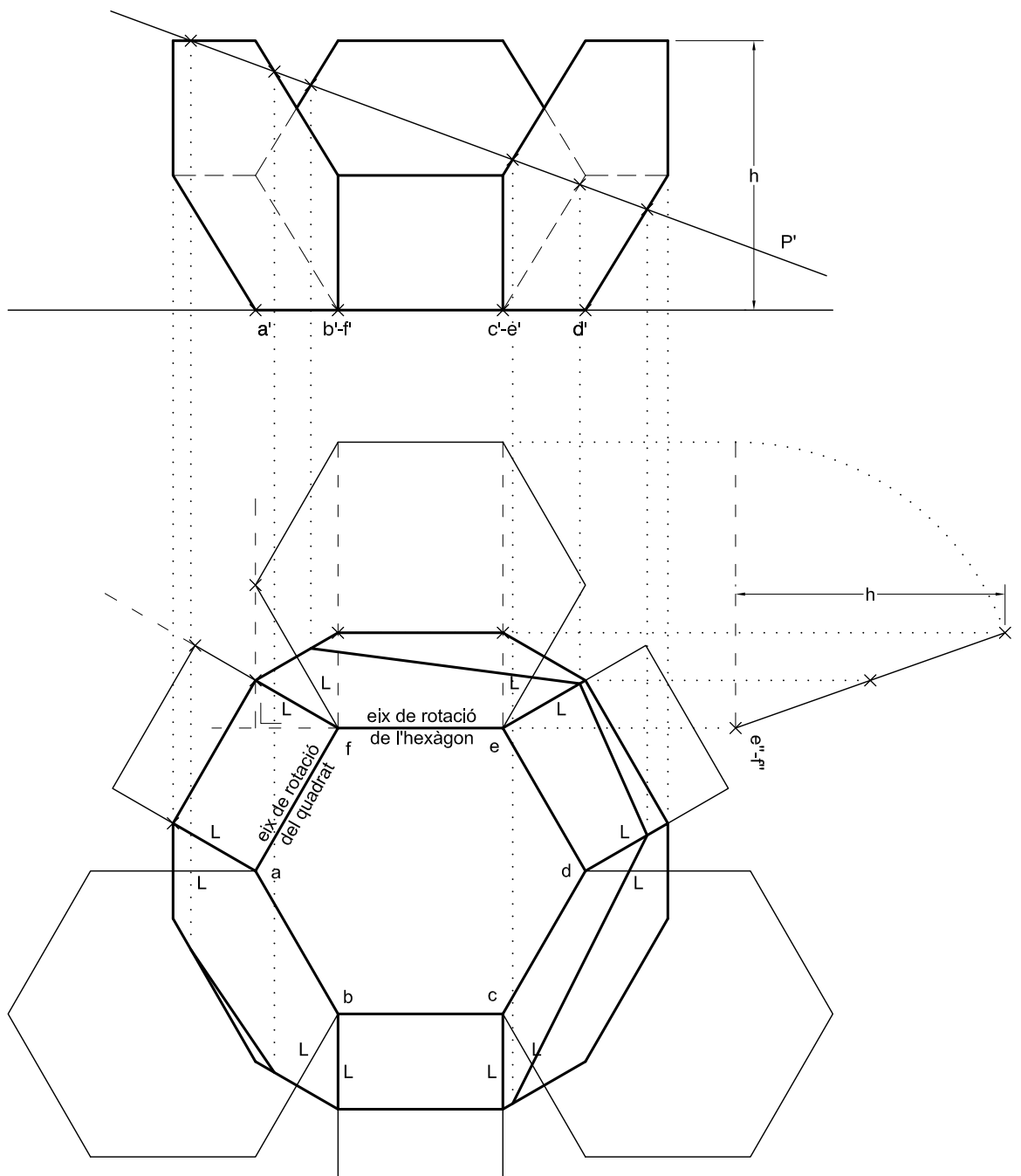
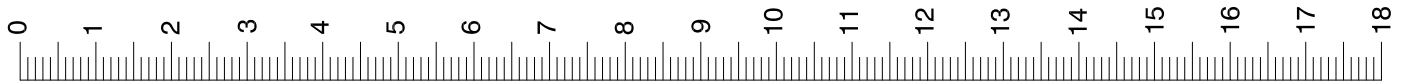



( 2B)

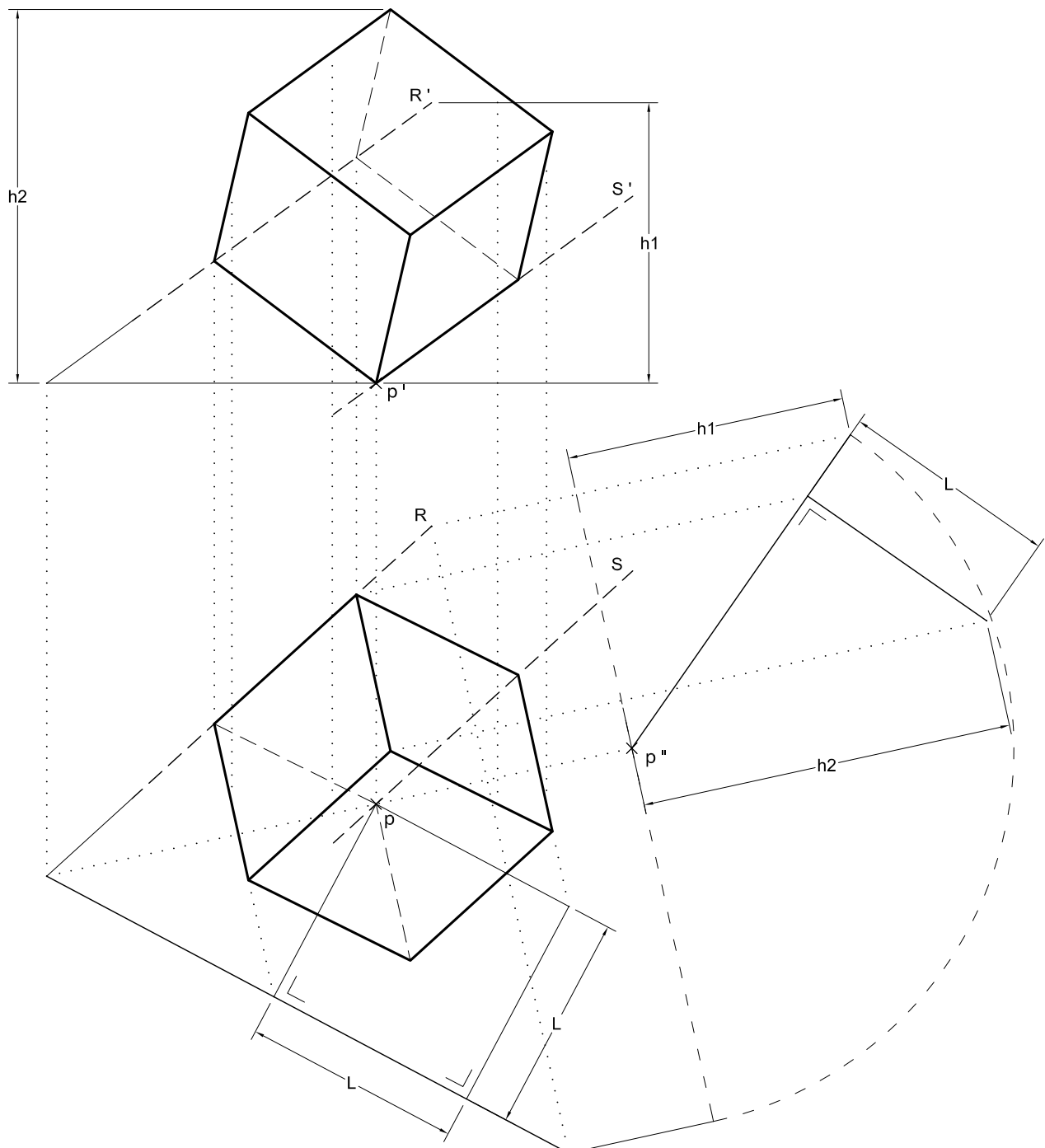
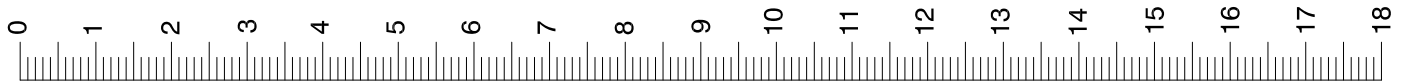



( 3A)

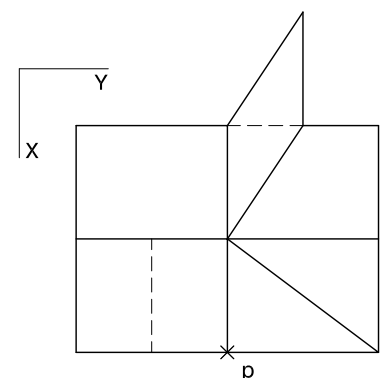
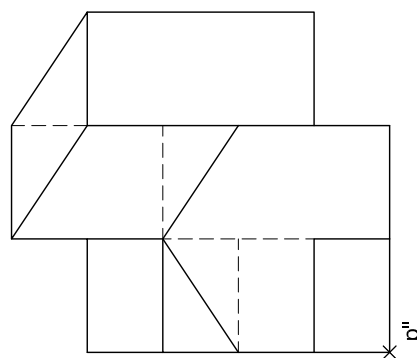
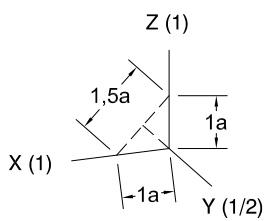
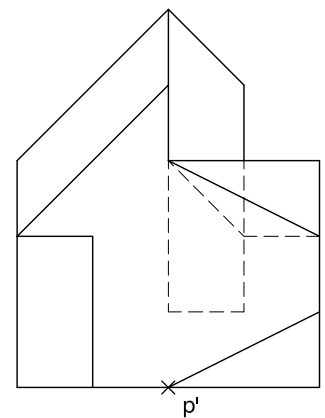
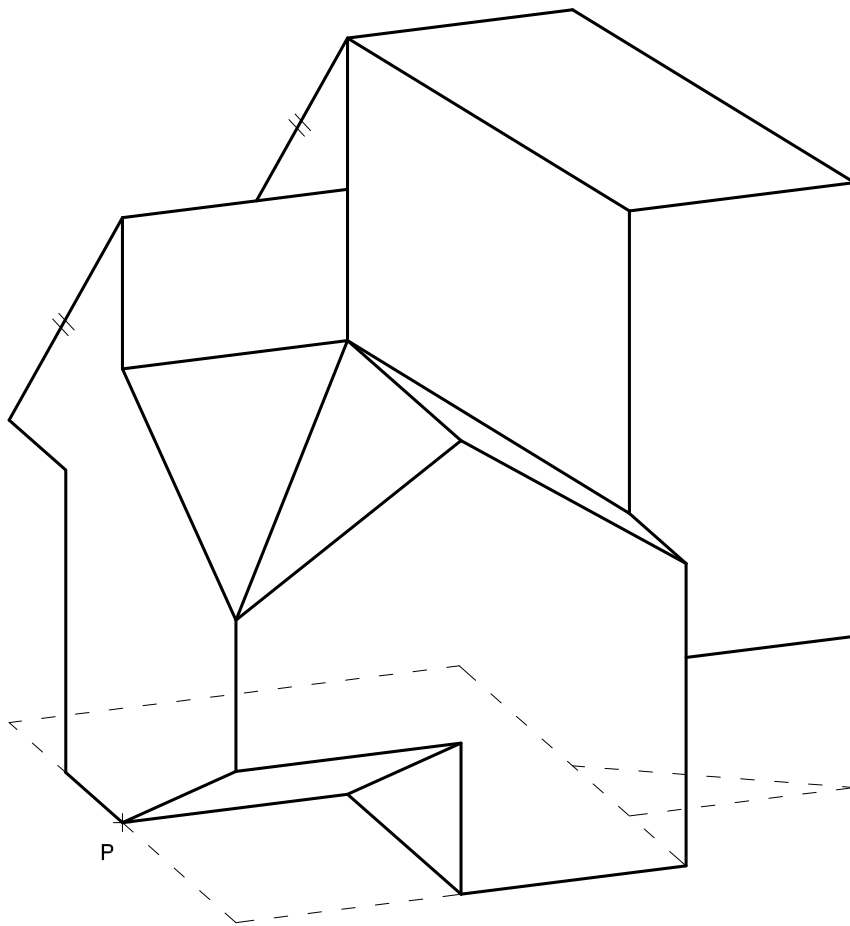
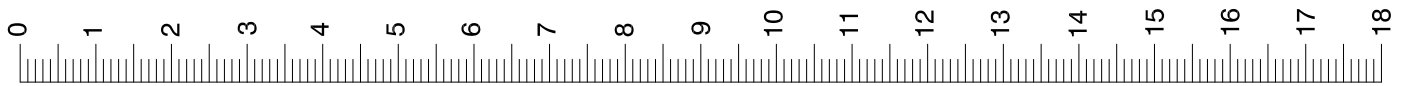



( 3B)

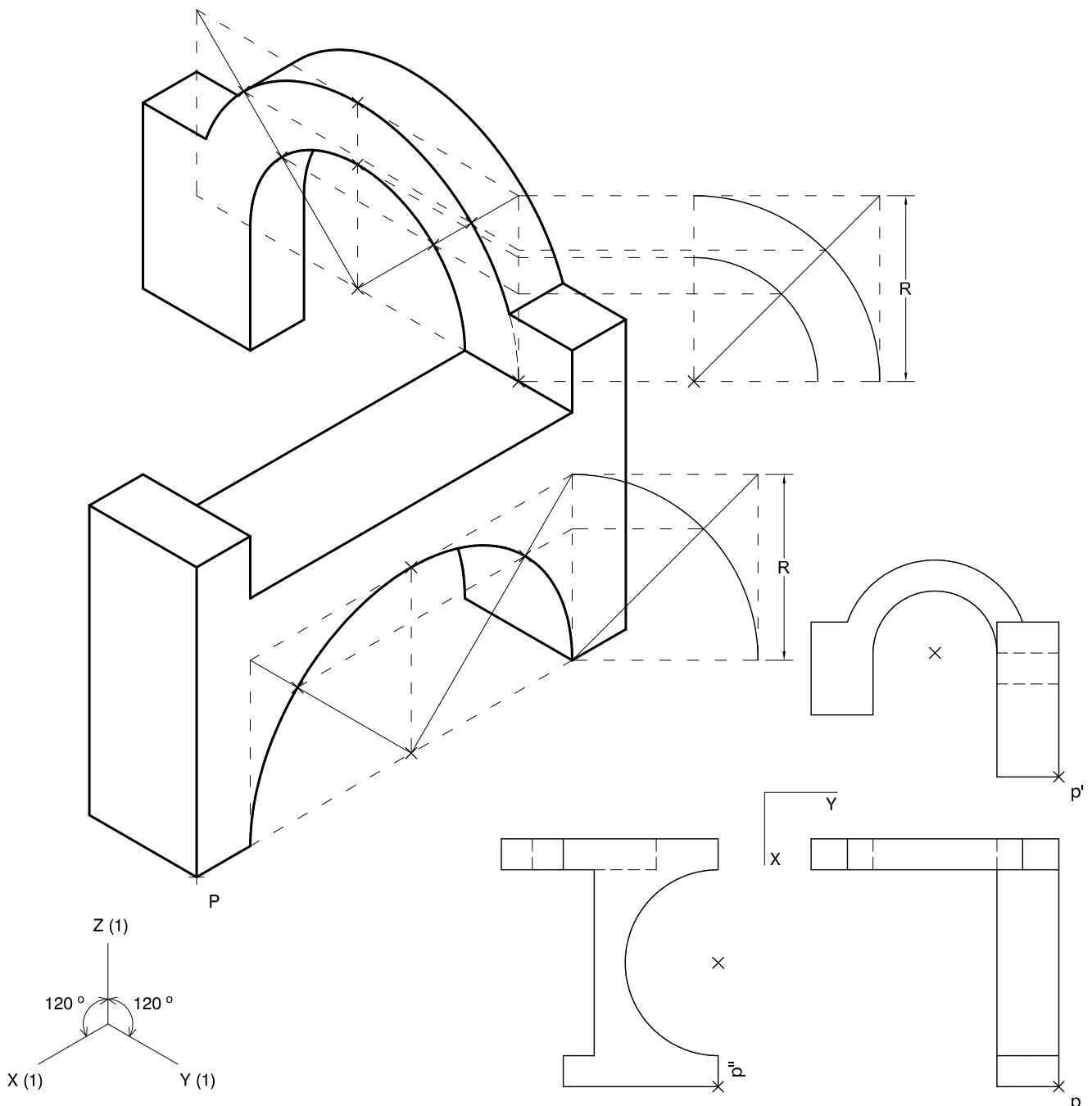
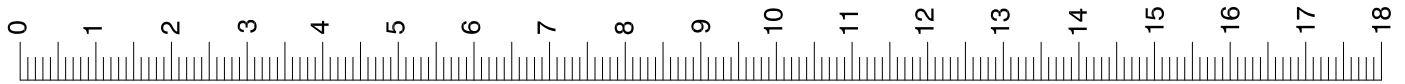



### SÈRIE 5

( 1A)

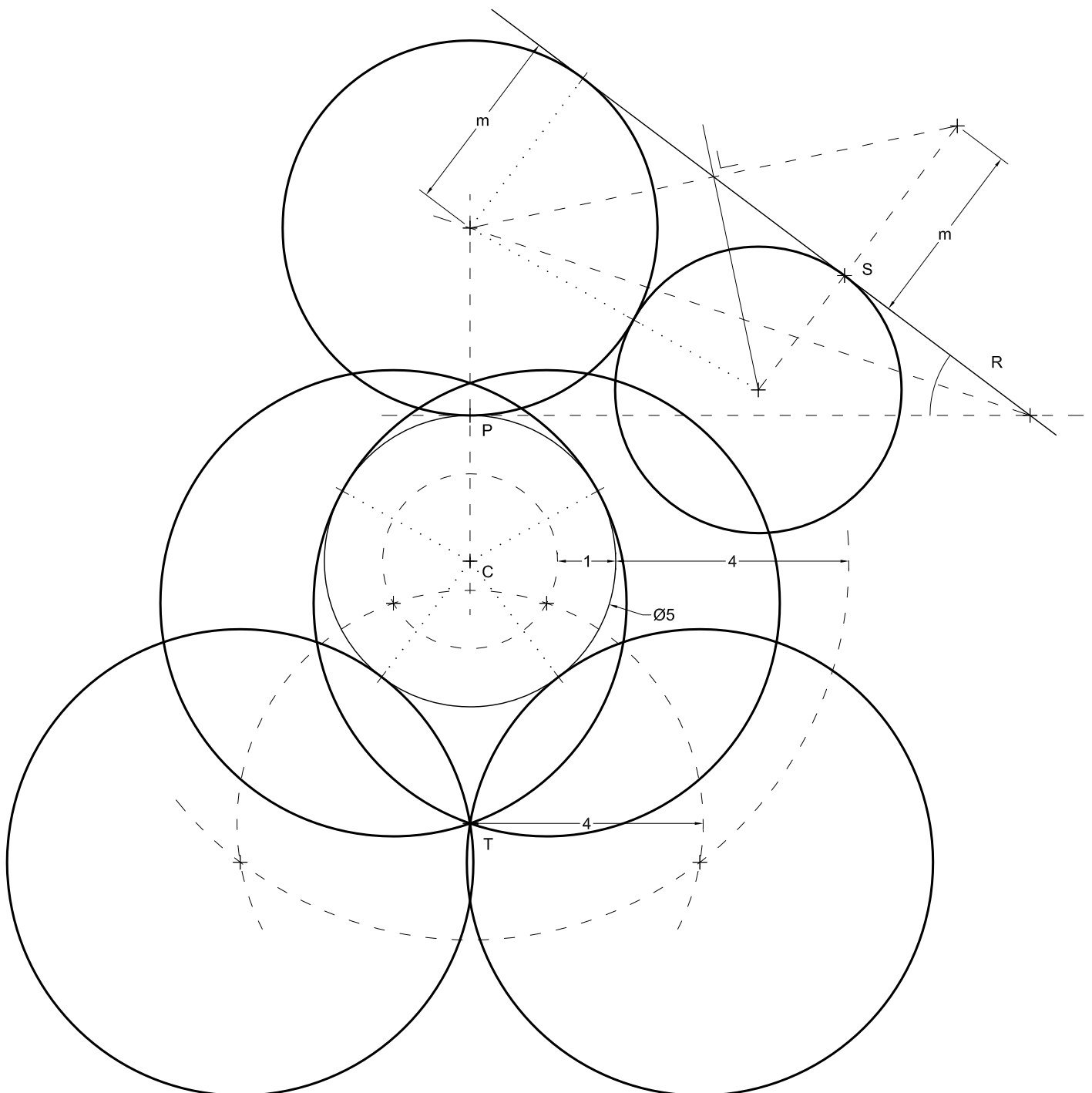
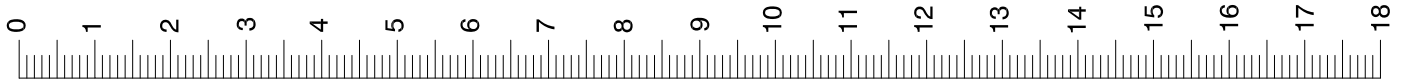



( 1B)

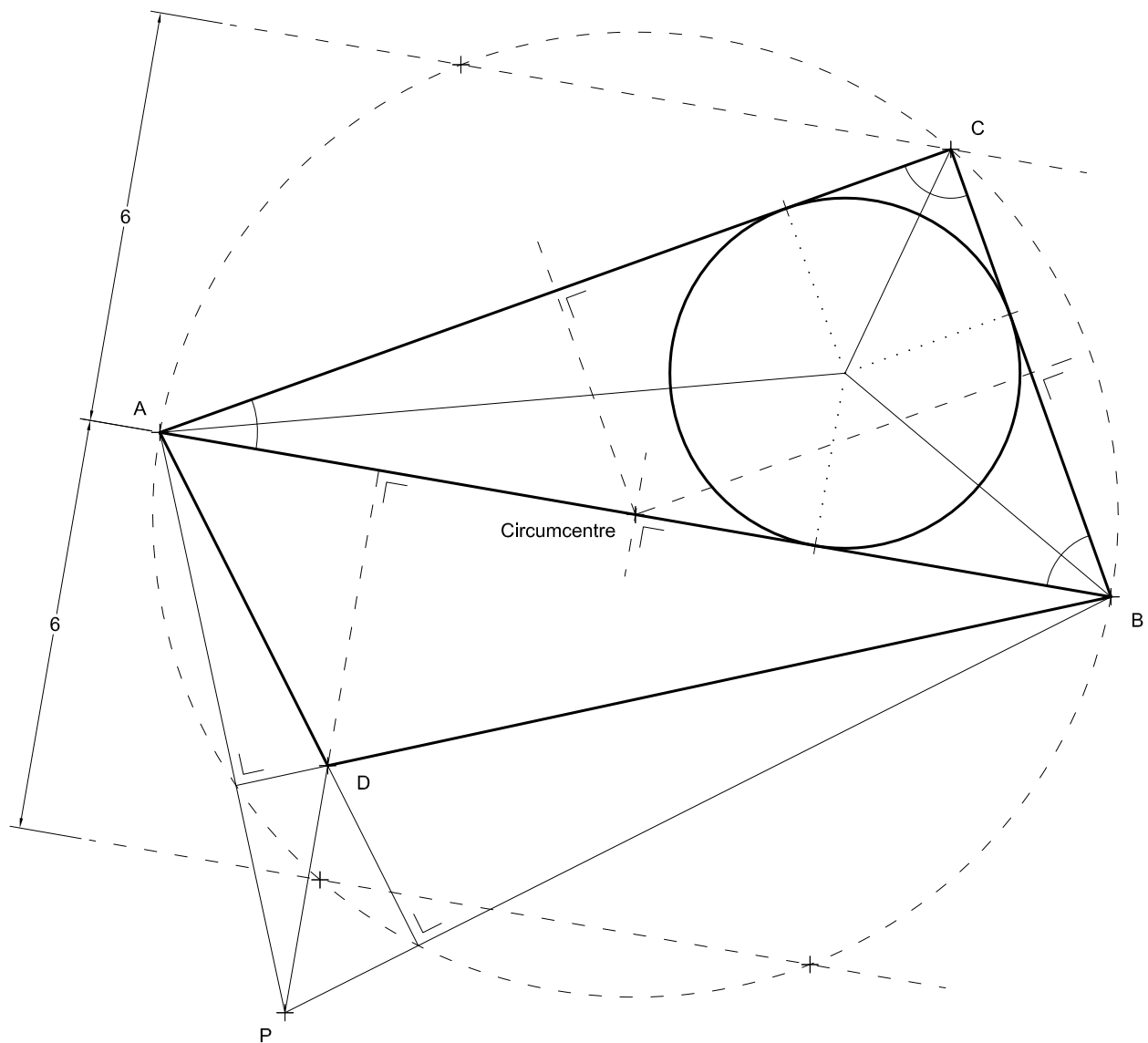
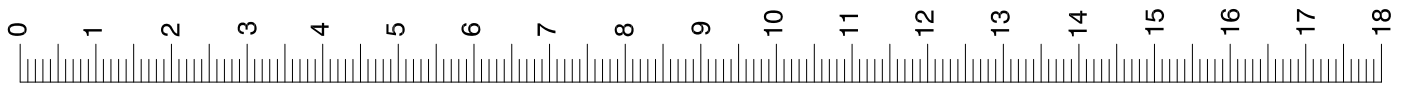

Segment  $AB$ : 10,5 metres





( 2A)

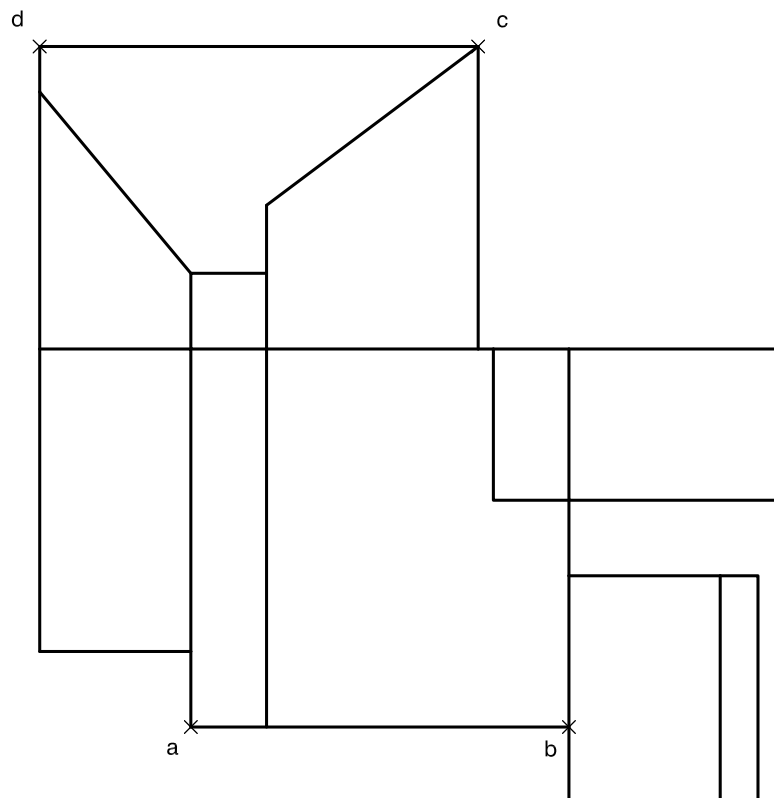
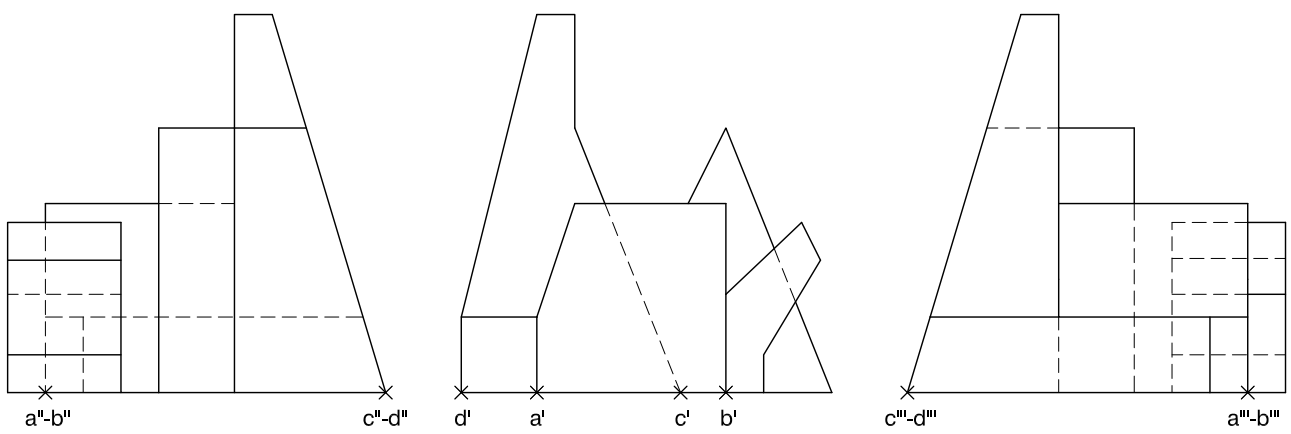
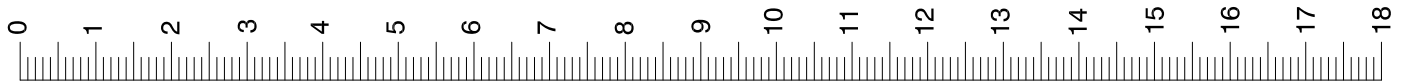



( 2B)

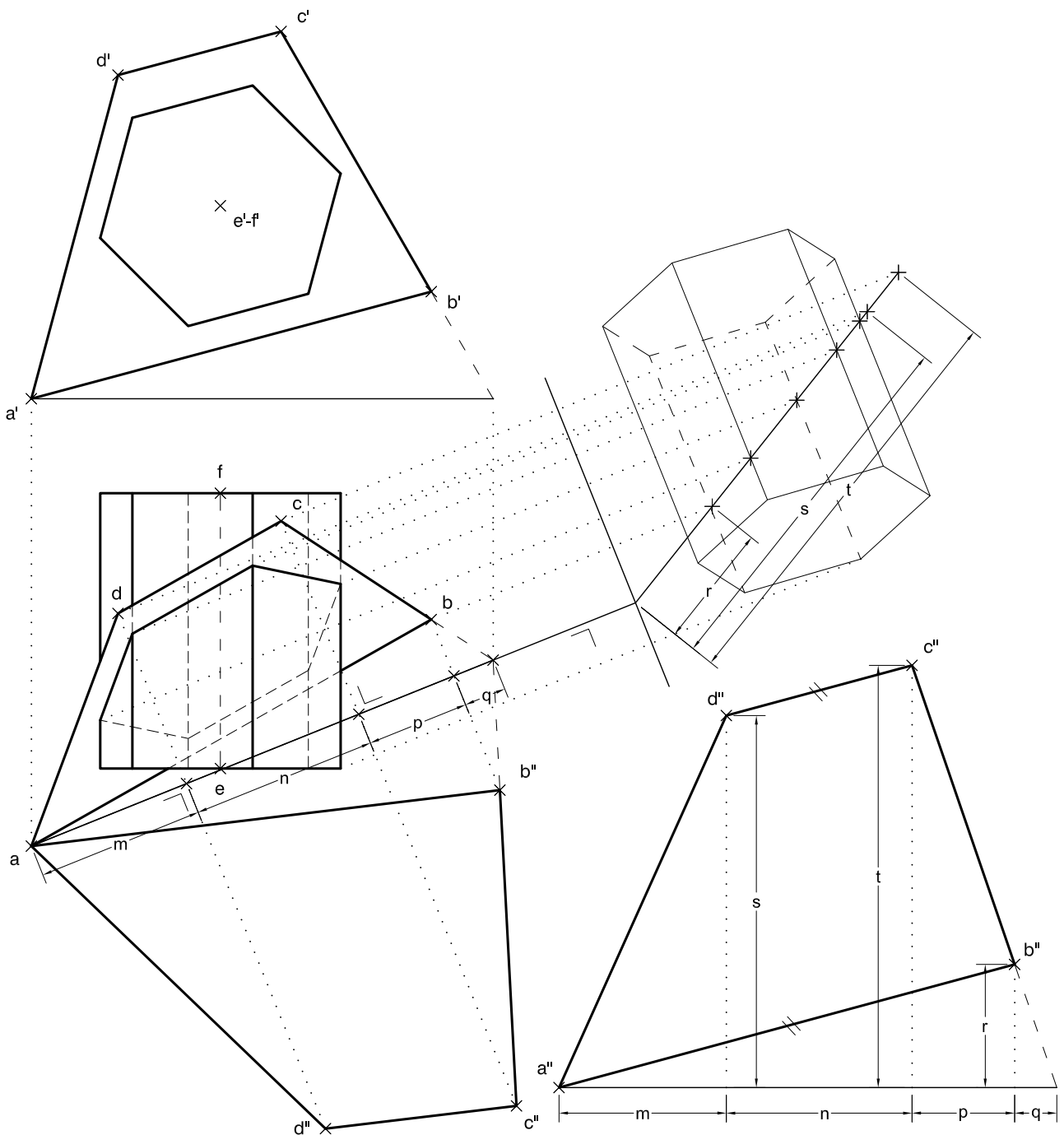
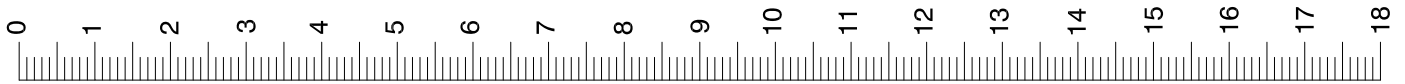



( 3A)

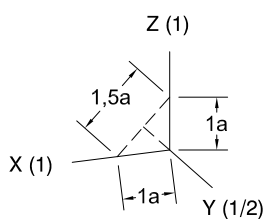
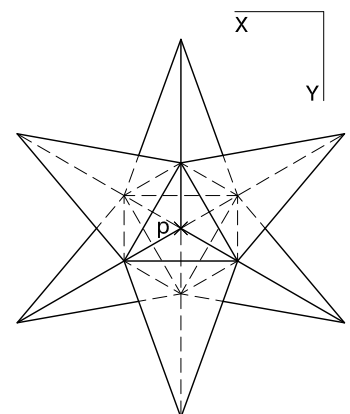
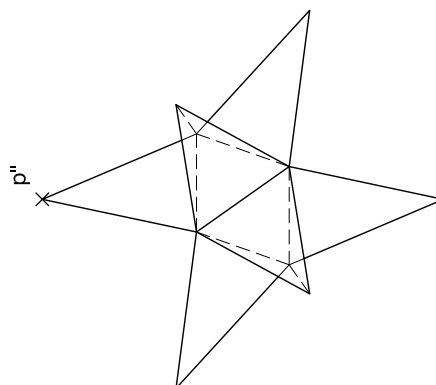
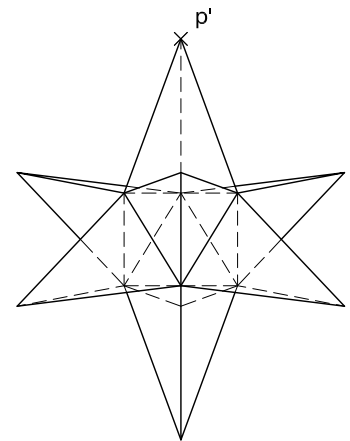
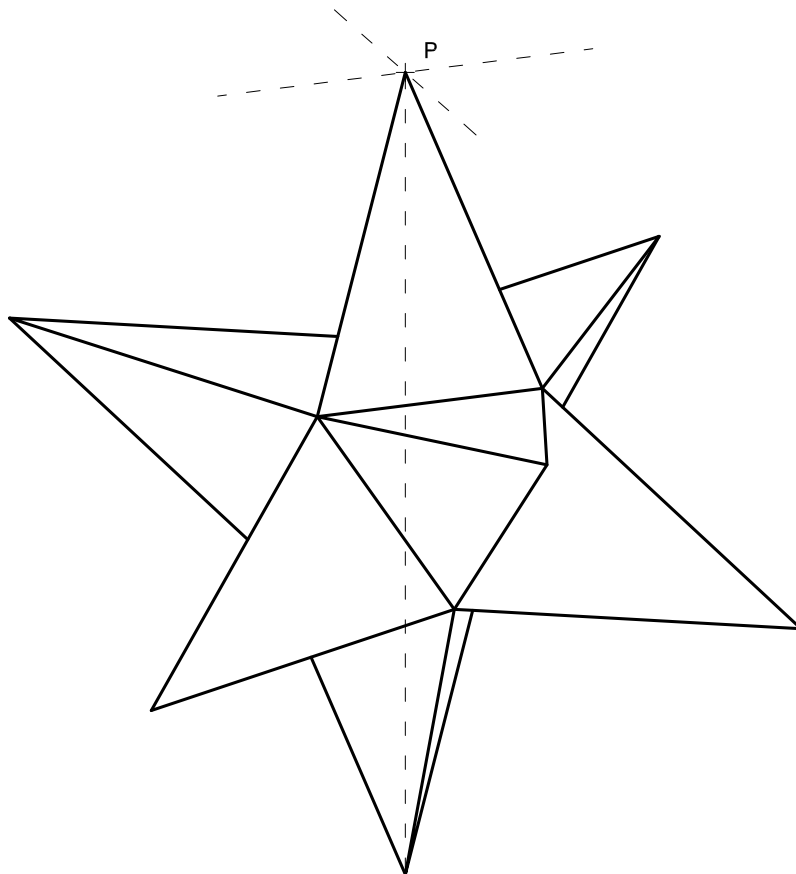
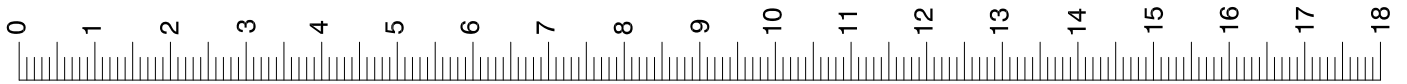



( 3B)

