

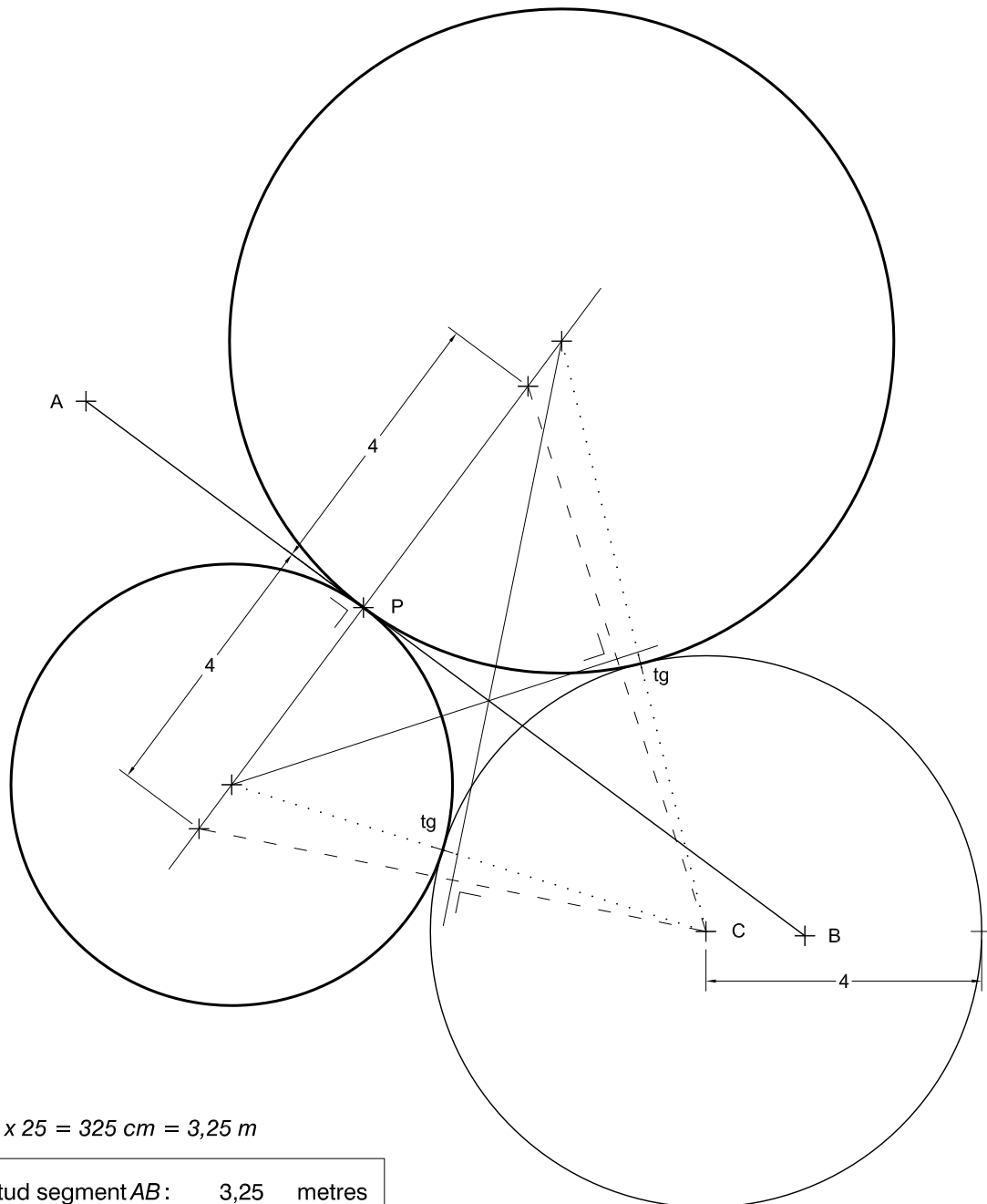

**SÈRIE 1**

(1-1A)

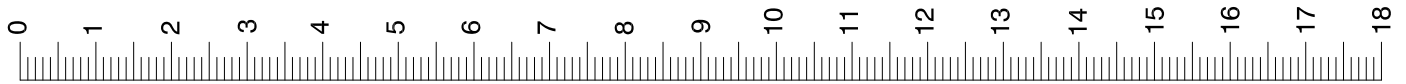

$13 \text{ cm} \times 25 = 325 \text{ cm} = 3,25 \text{ m}$

Longitud segment AB:	3,25	metres
----------------------	------	--------



(1-1B)

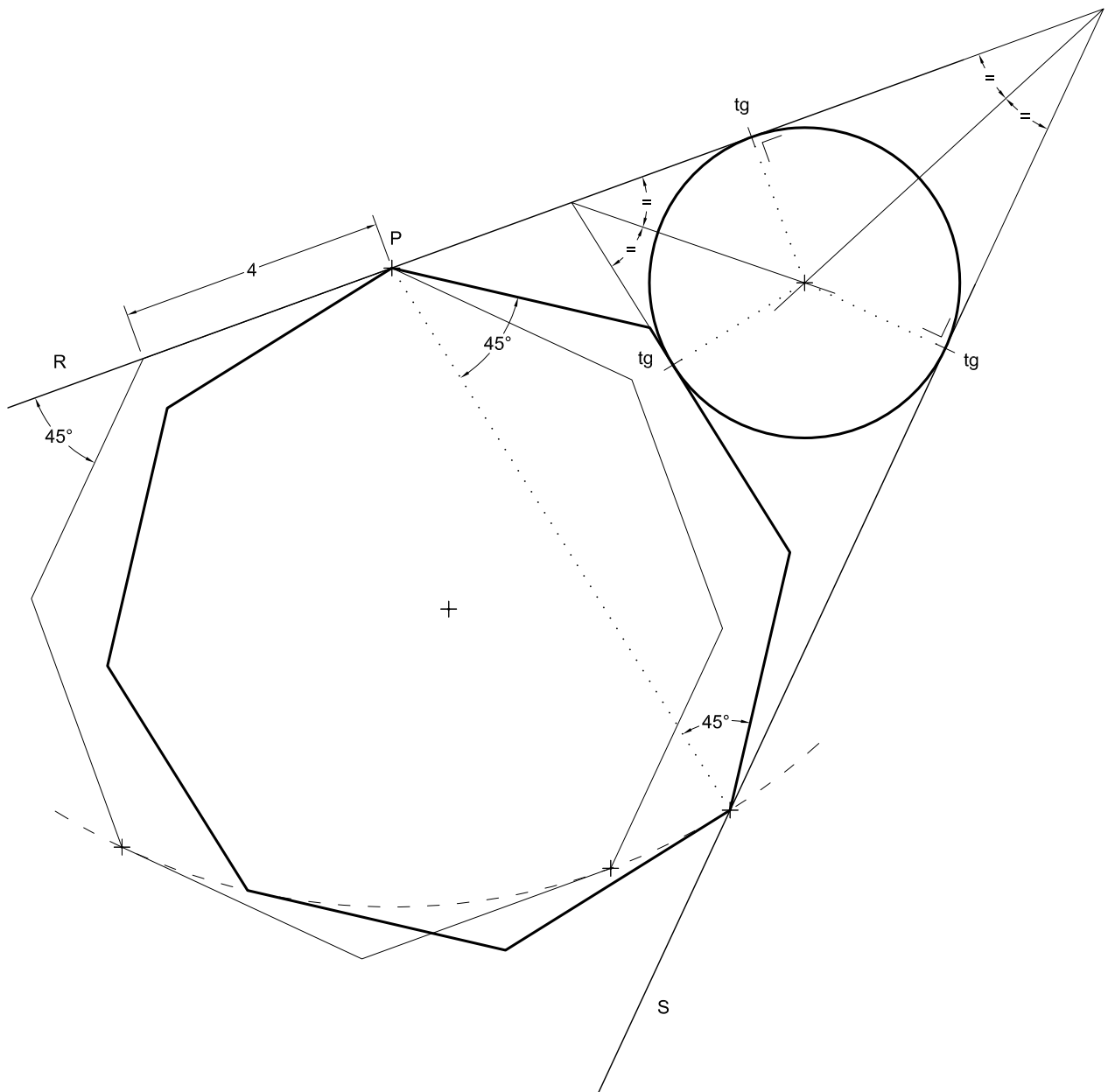
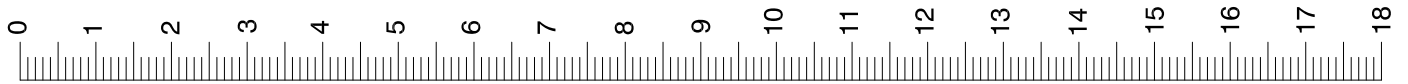



(1-2A)

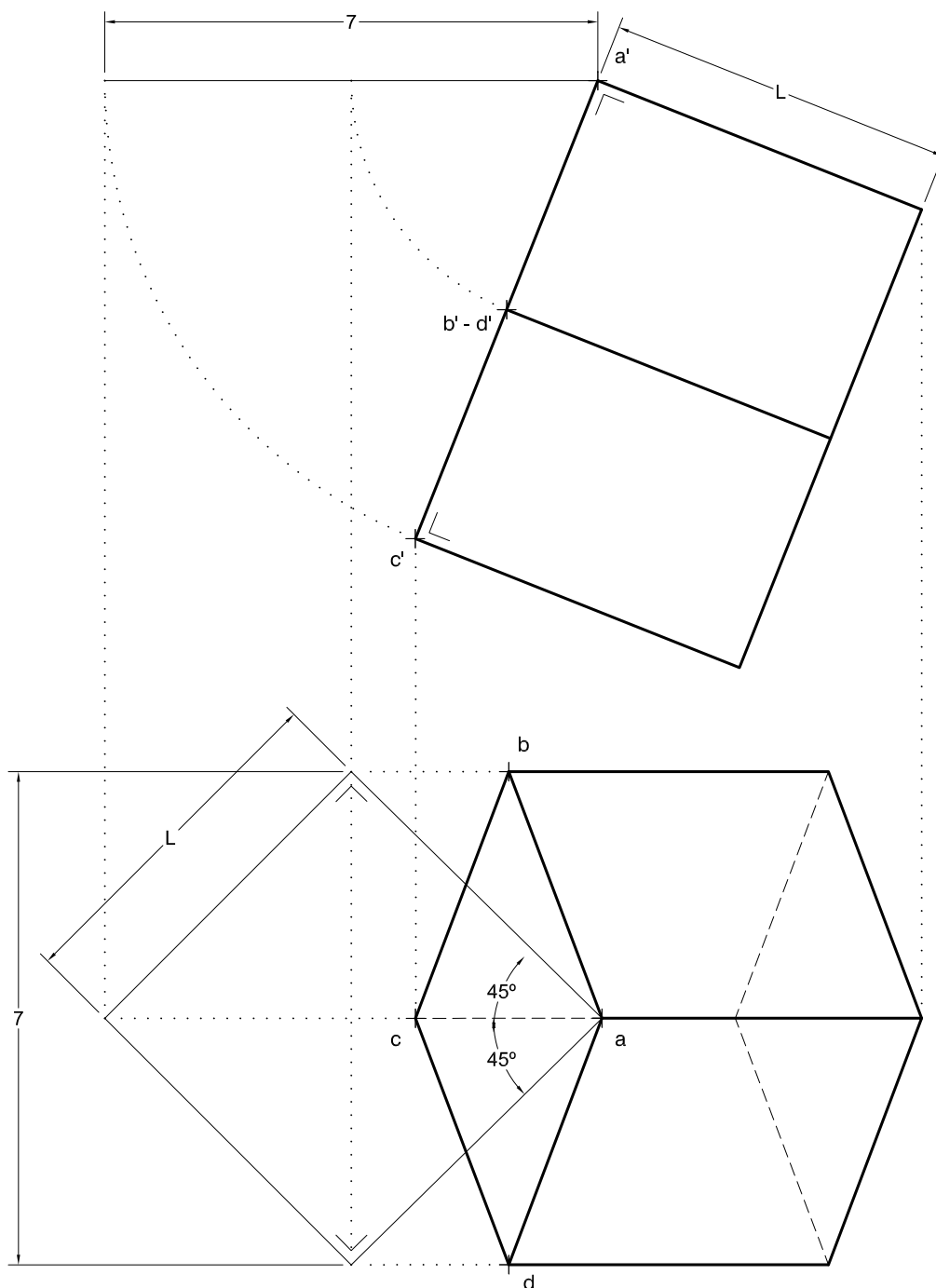
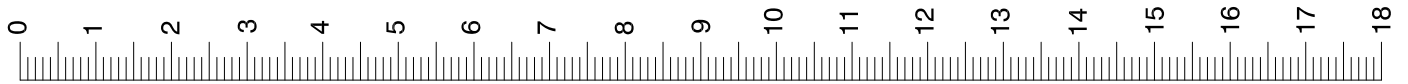



(1-2B)

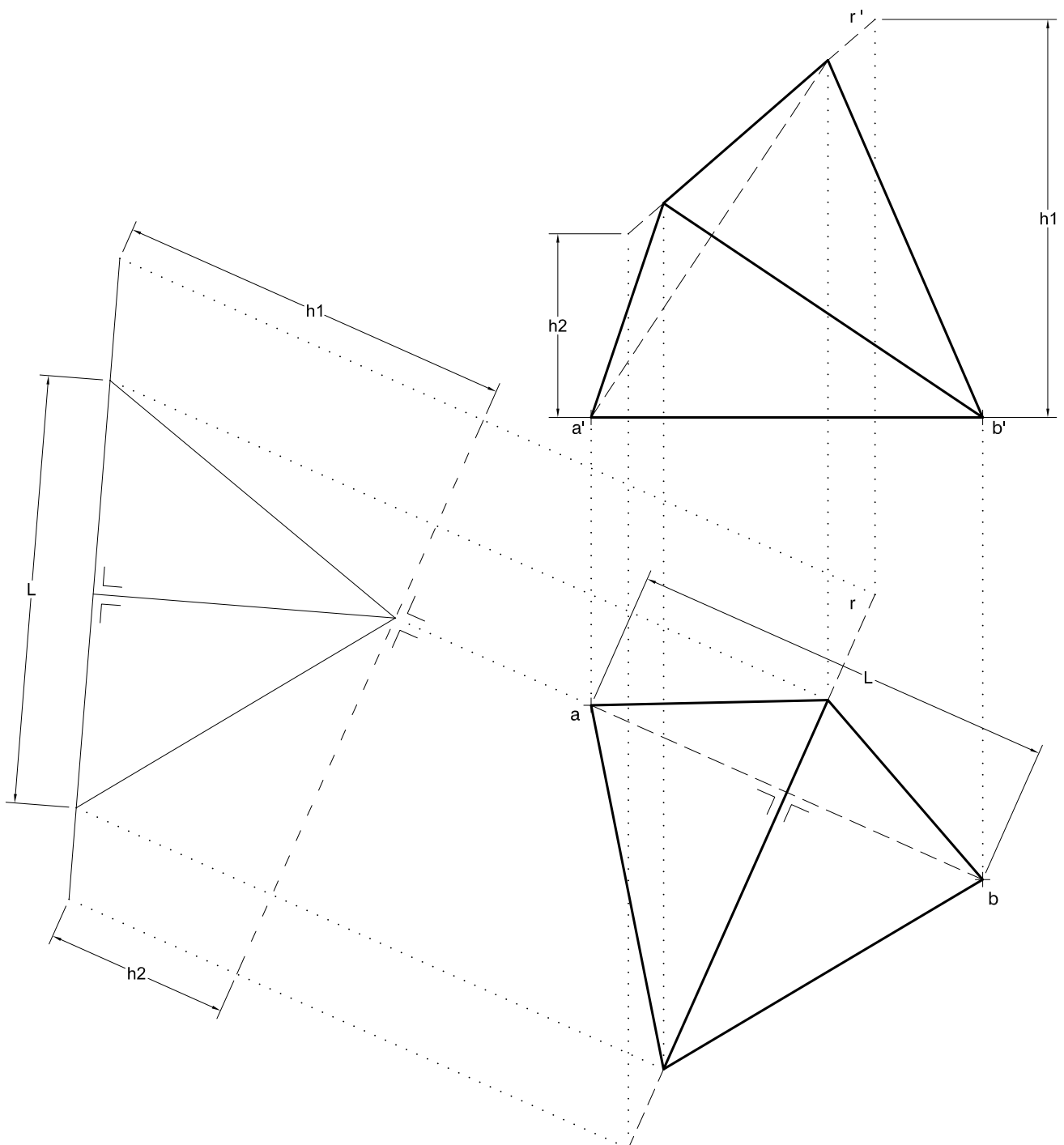
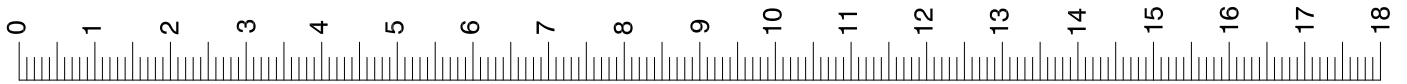



(1-3A)

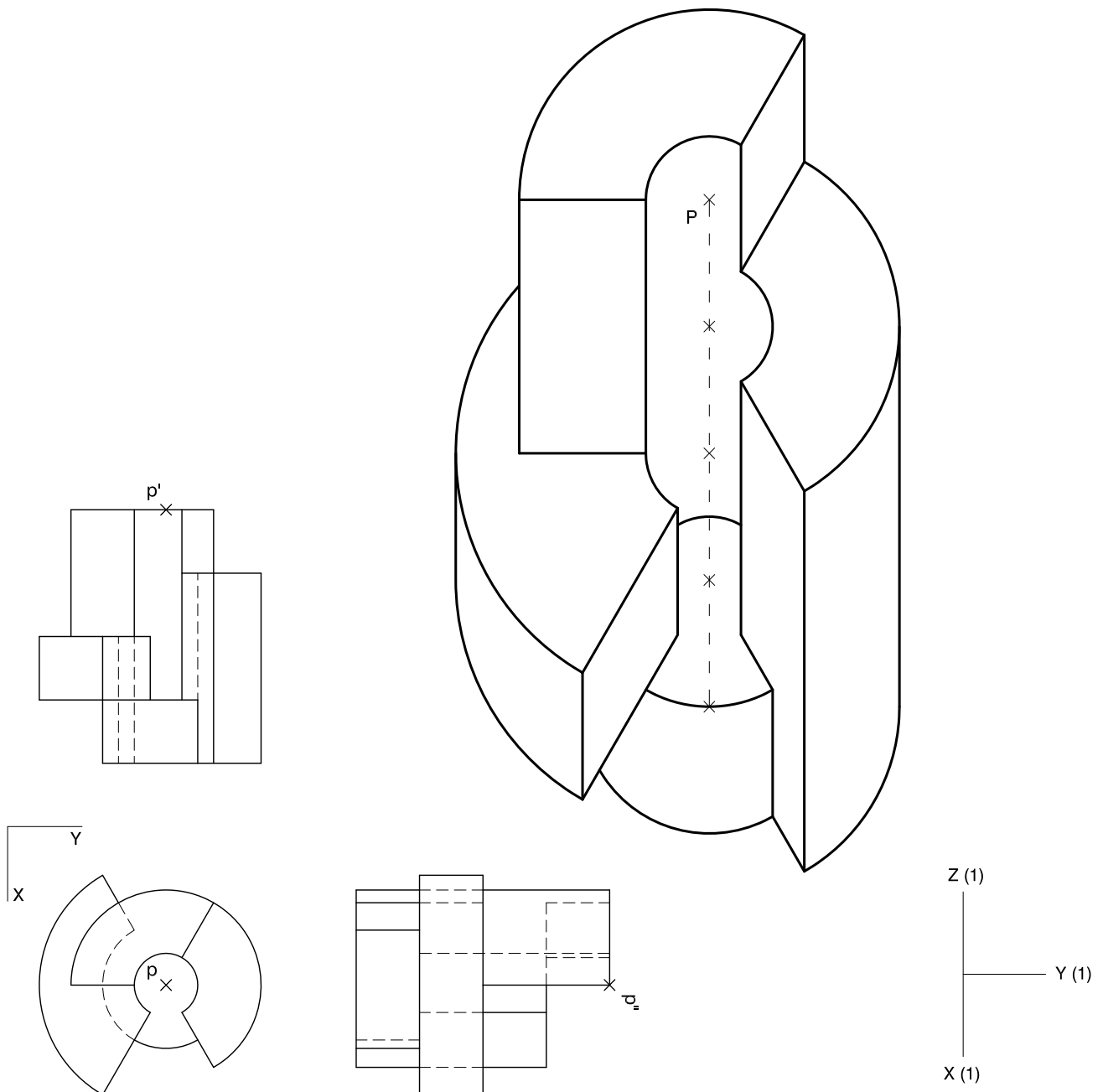
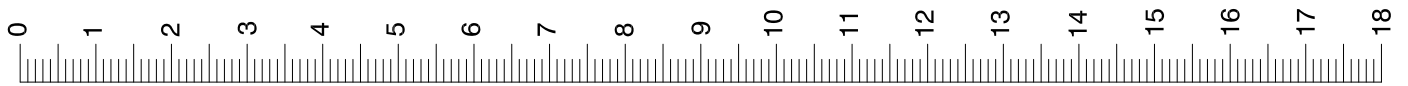



(1-3B)

